

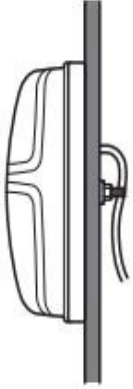

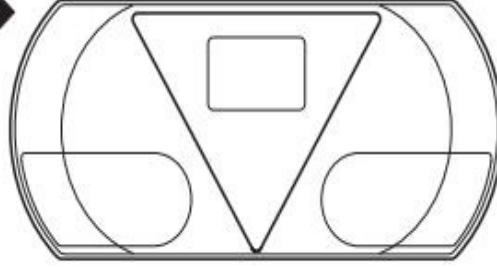

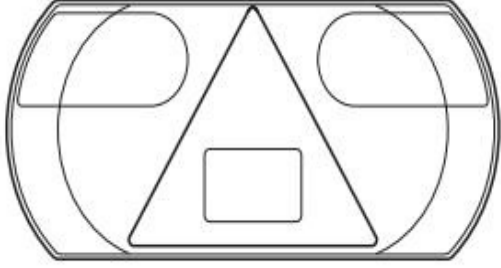

Mitat: 296x142x45mm
Paino: 1.00kg (netto 1.00kg)
Jännite: 10-30V
Sijainti: Taka, Oikea
IP-luokitus: IP67
Kuvaus: yhdistelmävalo: taka - jarru - vilkku - sumu - peruutus - kolmioheijastin, ECE, EMC, IP67. kiinnitys: 2xM6, ruuviväli 152mm

Mått: 296x142x45mm
Vikt: 1,00kg (netto 1,00kg)
Spänning: 10-30V
Placering: Bak, Höger
IP-klassning: IP67
Beskrivning: kombinationsljus: bak - broms - blinkers - dimljus - backljus - triangulär reflektor, ECE, EMC, IP67.
Montering: 2xM6, skruvavstånd 152mm

Dimensions: 296x142x45mm
Weight: 1.00kg (net 1.00kg)
Voltage: 10-30V
Location: Rear, Right
IP rating: IP67
Description: combination light: rear - brake - indicator - fog - reverse - triangle reflector, ECE, EMC, IP67. mounting: 2xM6, screw spacing 152mm

Asennusohje / Installationsanvisningar / Installation instructions 40-2011, 40-2012



- 1 
- 2 
- 3 
- 4 
- 5 

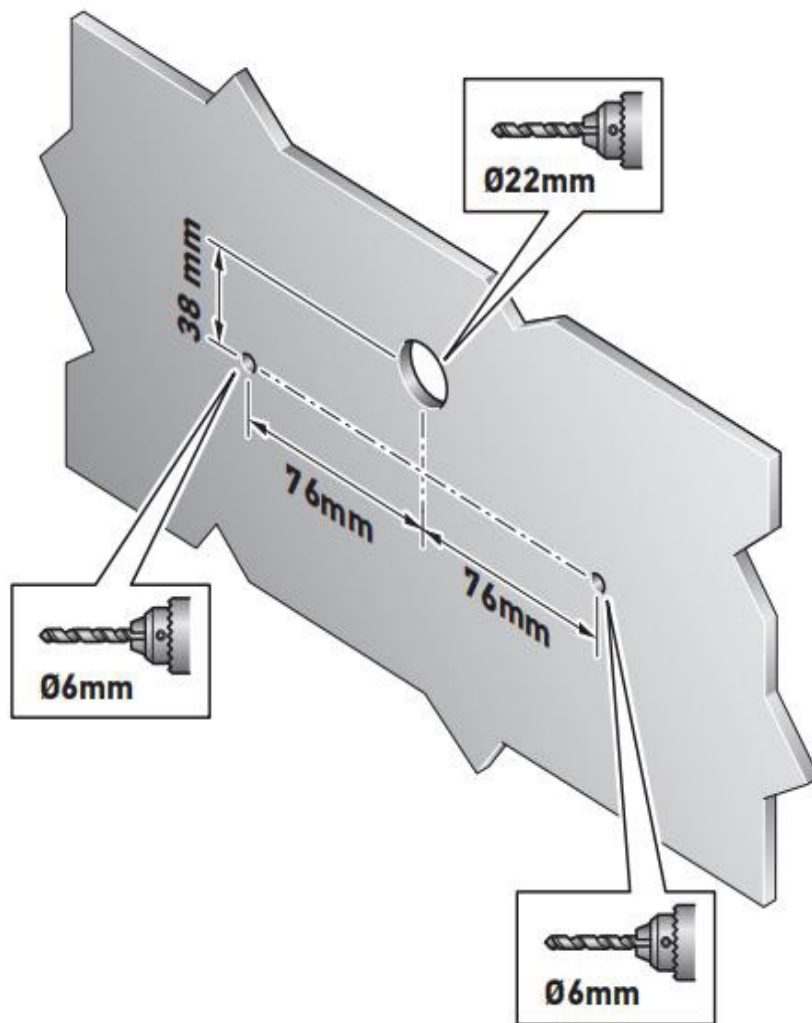

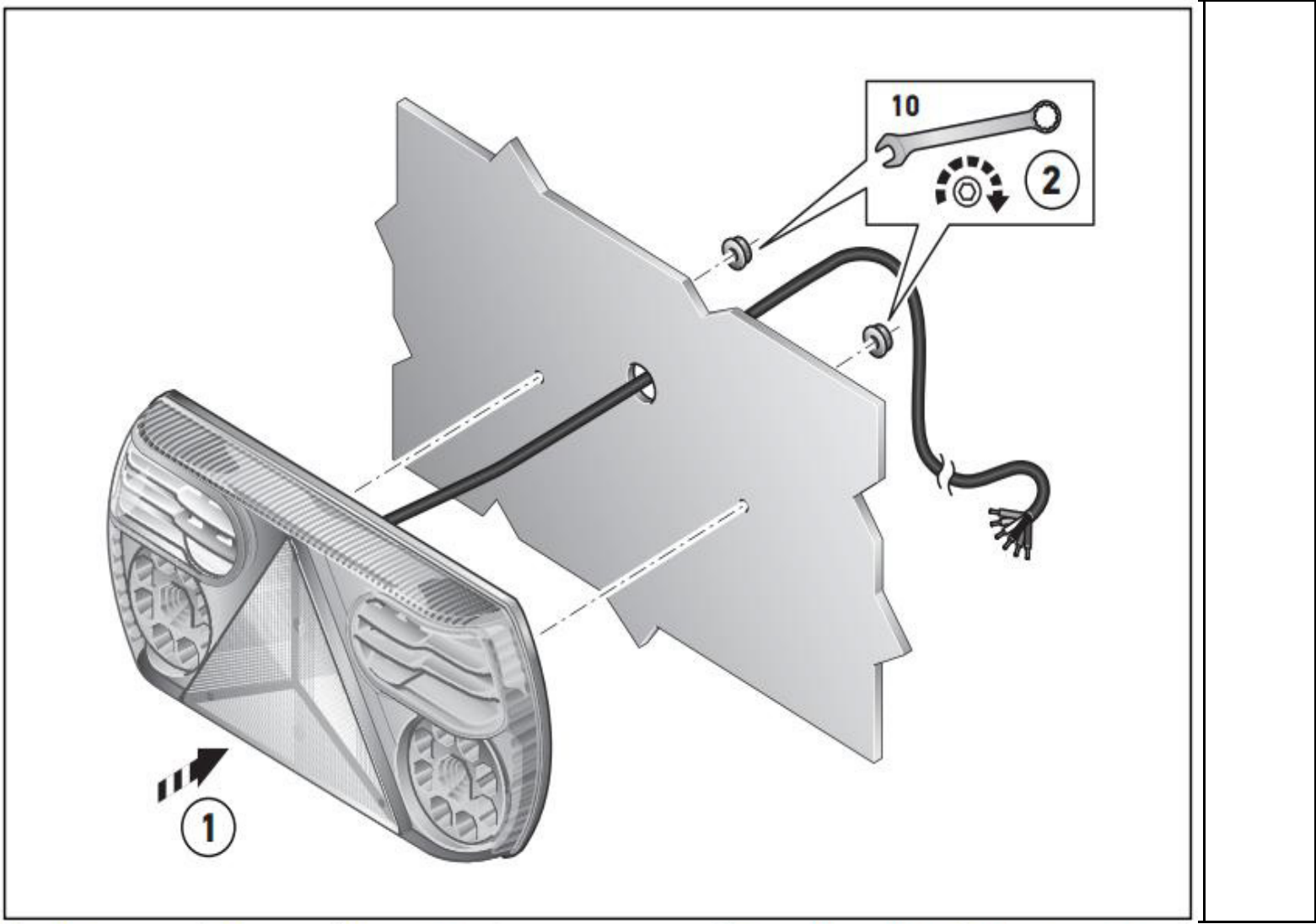

Valon toiminnot	Nimellisjännite	Jännitealue	Syöttöarvo	Sallittu ympäristön lämpötila	Suojausluokka IP 67
Takavallo	12V	12V - 24V	< 0,08 A < 1 W	-40°C – +50°C	Kestää upotusta
	24V		< 0,04 A < 1 W		
Jarruvalo	12V	12V - 24V	< 0,25 A < 3 W		
	24V		< 0,125 A < 3 W		
Suuntavilkku	12V	12V - 24V	< 0,25 A < 3 W		
	24V		< 0,125 A < 3 W		
Takasumuvalot	12V	12V - 24V	< 0,33 A < 4 W		
	24V		< 0,17 A < 4 W		
Peruutus	12V	12V - 24V	< 0,25 A < 3 W		
	24V		< 0,125 A < 3 W		

JOHDIN: toiminto;

PUNAINEN: takavallo;

Vihreä: suuntavilkku;

PUNAINEN/sininen: sumuvalo;

Vihreä/violetti: jarru;

Vihreä/ruskea: peruutus;

Musta: maa

Ljus-funktionerna	Nominell spänning	Spännings-område	Ingångsvärde	Driftstemperatur	Skyddsklass IP 67
Bakljus	12V	12V - 24V	<0,08 A <1 W	-40°C – +50°C	Tål nedsänkning
	24V		<0,04 A <1 W		
Bromsljus	12V	12V - 24V	<0,25 A <3 W		
	24V		<0,125 A <3 W		
Blinkers	12V	12V - 24V	<0,25 A <3 W		
	24V		<0,125 A <3 W		
Dimljus bak	12V	12V - 24V	<0,33 A <4 W		
	24V		<0,17 A <4 W		
Backljus	12V	12V - 24V	<0,25 A <3 W		
	24V		<0,125 A <3 W		

LEDNING: funktion;

RÖD: bakljus;

grön: blinkers;

RÖD/blå: dimljus;

grön/lila: broms;

grön/brun: back;

svart: jord

Light Function	Nominal voltage	Range of voltage	Input values	Admissible ambient temperature	Class of protection IP 67
Tail light	12V	12V - 24V	< 0,08 A < 1 W	-40°C up to +50°C	Submersible
	24V		< 0,04 A < 1 W		
Stop light	12V	12V - 24V	< 0,25 A < 3 W		
	24V		< 0,125 A < 3 W		
Turn indicator	12V	12V - 24V	< 0,25 A < 3 W		
	24V		< 0,125 A < 3 W		
Rear fog lamps	12V	12V - 24V	< 0,33 A < 4 W		
	24V		< 0,17 A < 4 W		
Reverse	12V	12V - 24V	< 0,25 A < 3 W		
	24V		< 0,125 A < 3 W		

WIRE: function;
RED: tail;
green: DI;
RED/blue: fog;
green/purple: stop;
green/brown: reverse;
black: GND

ECE-R48
ECE-R6
ECE-R7
ECE-R23
ECE-R3
ECE-R38

